

# Data Sheet

Rev. 1.1 / August 2010

# ZLED7000

40V LED Driver with Internal Switch



# ZLED7000

40V LED Driver with Internal Switch



## Brief Description

The ZLED7000, one of our ZLED Family of LED control ICs, is an inductive step-down converter that is optimal for driving a single LED or multiple LEDs (connected in series) from a voltage source greater than the voltage rating of the LED. The ZLED7000 operates in continuous mode. Capable of operating efficiently with voltage supplies ranging from 6 VDC to 40 VDC, it is ideal for low-voltage lighting applications. The ZLED7000 minimizes current consumption by remaining in a low-current standby mode (output is off) until a voltage of  $\geq 0.3V$  is applied to the ADJ pin.

In operating mode, the ZLED7000 can source LEDs with an output current of  $\leq 750mA$  ( $\leq 30$  watts of output power) that is externally adjustable.\* The ZLED7000's integrated output switch and high-side current sensing circuit use an external resistor to adjust the average output current. Linearity is achieved via an external control signal at the ZLED7000's ADJ pin, implemented either as a pulse-width modulation (PWM) waveform for a gated output current or a DC voltage for a continuous current.

## Features

- Capable of up to 95% efficiency\*
- Operates in continuous mode with a wide input range from 6 VDC to 40 VDC
- Integrated 40V power switch
- One pin on/off or brightness control via PWM or DC voltage control signal input
- Switching frequency:  $\leq 1MHz$
- Dimming rate: 1200:1 (typical)
- Output current accuracy: 5% (typical)
- Built-in thermal shutdown and open-circuit protection for LED
- Very few external components needed for operation
- Broad range of applications: outputs up to  $\leq 750mA$
- SOT89-5 package

## Application Examples

- Illuminated LED signs and other displays
- LED traffic and street lighting (low-voltage)
- Architectural LED lighting, including low-voltage applications for buildings
- Halogen replacement LEDs (low-voltage)
- LED backlighting
- General purpose exterior and interior LED lighting, including applications requiring low-voltage
- General purpose low-voltage industrial applications

## ZLED7000 Application Circuit

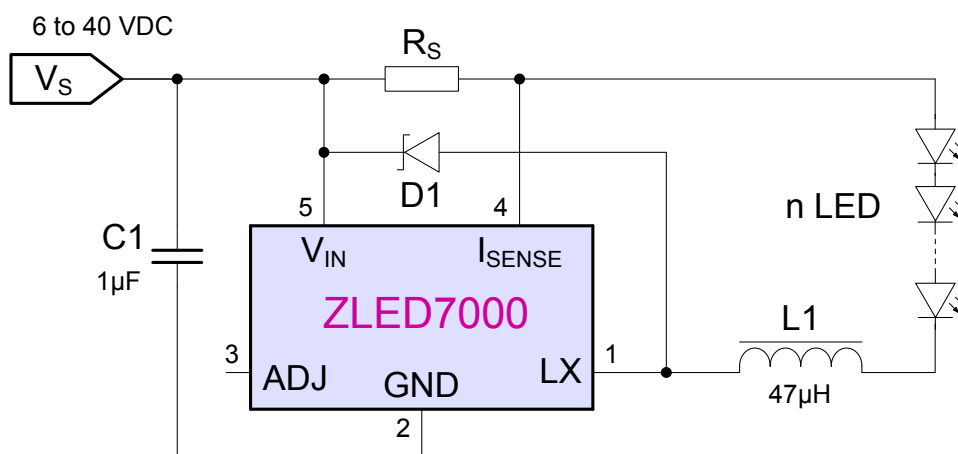

\* See section 2.3 for details

# ZLED7000

40V LED Driver with Internal Switch



## SOT89-5 Package Dimensions and Pin Assignments

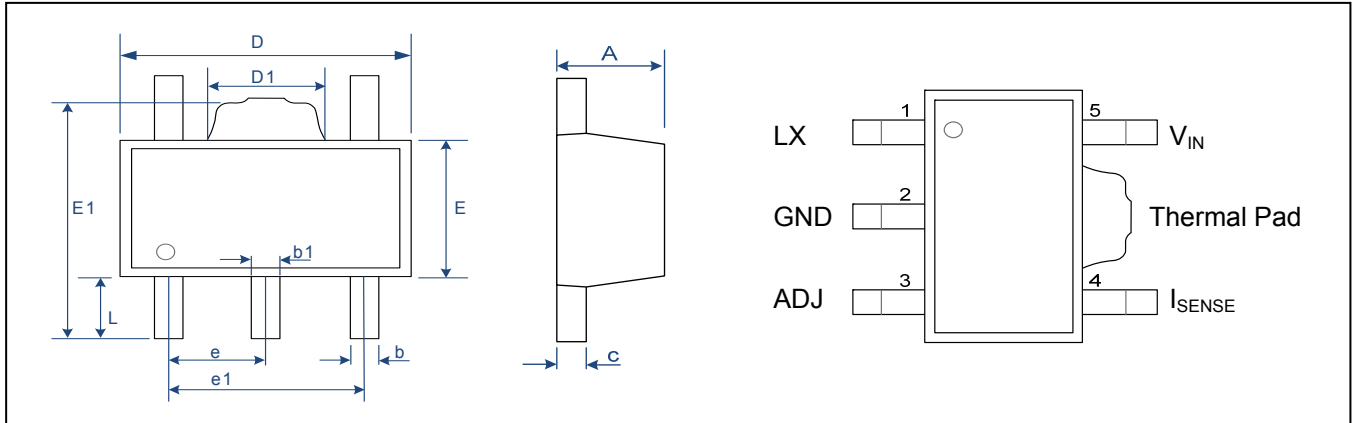

Symbol	Dimension (mm)		Symbol	Dimension (mm)	
	Min	Max		Min	Max
A	1.400	1.600	E	2.300	2.600
b	0.320	0.520	E1	3.940	4.250
b1	0.360	0.560	e	1.500 Typ	
c	0.350	0.440	e1	2.900	3.100
D	4.400	4.600	L	0.900	1.100
D1	1.400	1.800			

## Ordering Information

Product Sales Code	Description	Package
ZLED7000-Z11R	ZLED7000 – 40V LED Driver	SOT89-5 (Tape & Reel)
ZLED7000KIT-D1	ZLED7000 used in a MR16 Halogen replacement Demo Kit 12VAC/VDC, including 1 ZLED-PCB1	Kit
ZLED-PCB1	Test PCB with one 3W white High Brightness (HB) LED, cascable to one multiple LED string	Printed Circuit Board (PCB)
ZLED-PCB2	10 unpopulated test PCBs for modular LED string with footprints of 9 common HB LED types	Printed Circuit Board (PCB)

## Sales and Further Information

[www.zmdi.com](http://www.zmdi.com)

[LED\\_Drivers@zmdi.com](mailto:LED_Drivers@zmdi.com)

**Zentrum Mikroelektronik Dresden AG (ZMD AG)**  
Grenzstrasse 28  
01109 Dresden  
Germany

**ZMD America, Inc.**  
8413 Excelsior Drive  
Suite 200  
Madison, WI 53717  
USA

**Zentrum Mikroelektronik Dresden AG, Japan Office**  
2nd Floor, Shinbashi Tokyu Bldg.  
4-21-3, Shinbashi, Minato-ku  
Tokyo, 105-0004  
Japan

**ZMD Far East, Ltd.**  
3F, No. 51, Sec. 2,  
Keelung Road  
11052 Taipei  
Taiwan

Phone +49 (0)351.8822.7.533  
Fax +49(0)351.8822.8.7533

Phone +1 (608) 829-1987  
Fax +1 (631) 549-2882

Phone +81.3.6895.7410  
Fax +81.3.6895.7301

Phone +886.2.2377.8189  
Fax +886.2.2377.8199

**DISCLAIMER:** This information applies to a product under development. Its characteristics and specifications are subject to change without notice. Zentrum Mikroelektronik Dresden AG (ZMD AG) assumes no obligation regarding future manufacture unless otherwise agreed to in writing. The information furnished hereby is believed to be true and accurate. However, under no circumstances shall ZMD AG be liable to any customer, licensee, or any other third party for any special, indirect, incidental, or consequential damages of any kind or nature whatsoever arising out of or in any way related to the furnishing, performance, or use of this technical data. ZMD AG hereby expressly disclaims any liability of ZMD AG to any customer, licensee or any other third party, and any such customer, licensee and any other third party hereby waives any liability of ZMD AG for any damages in connection with or arising out of the furnishing, performance or use of this technical data, whether based on contract, warranty, tort (including negligence), strict liability, or otherwise.

# ZLED7000

40V LED Driver with Internal Switch



## Contents

1	IC Characteristics .....	6
1.1	Absolute Maximum Ratings .....	6
1.2	Operating Conditions .....	6
1.3	Electrical Parameters .....	6
1.4	Characteristic Operating Curves .....	8
2	Circuit Description .....	10
2.1	Voltage Supply .....	10
2.2	ZLED7000 Standby Mode .....	10
2.3	Output Current Control .....	10
2.3.1	Output Current and $R_S$ .....	10
2.3.2	PWM Control .....	11
2.3.3	External DC Voltage Control of Output Current .....	11
2.3.4	Microcontroller LED Control .....	12
3	Application Circuit Design .....	13
3.1	External Component – Inductor L1 .....	13
3.2	External Component – Capacitor C1 .....	14
3.3	External Component – Diode D1 .....	14
3.4	Output Ripple .....	15
4	Operating Conditions .....	16
4.1	Thermal Conditions .....	16
4.2	Thermal Shut-Down Protection .....	16
4.3	Open-Circuit Protection .....	16
5	ESD/Latch-Up-Protection .....	16
6	Pin Configuration and Package .....	17
7	Layout Requirements .....	18
7.1	Layout Considerations for ADJ (Pin 3) .....	18
7.2	Layout Considerations for LX (Pin 1) .....	18
7.3	Layout Considerations for $V_{IN}$ (Pin 5) and the External Decoupling Capacitor (C1) .....	18
7.4	Layout Considerations for GND (Pin 2) .....	18
7.5	Layout Considerations for High Voltage Traces .....	18
7.6	Layout Considerations for the External Coil (L1) .....	18
7.7	Layout Considerations for the External Current Sense Resistor ( $R_S$ ) .....	18
8	Ordering Information .....	18
9	Document Revision History .....	19

# ZLED7000

40V LED Driver with Internal Switch



## List of Figures

Figure 2.1	Directly Driving ADJ Input with a PWM Control Signal .....	11
Figure 2.2	External DC Control Voltage at ADJ Pin.....	11
Figure 2.3	Driving ADJ Input from a Microcontroller.....	12
Figure 3.1	Output Ripple Reduction .....	15
Figure 6.1	Pin Configuration and Package Drawing SOT89-5 .....	17

## List of Tables

Table 1.1	Absolute Maximum Ratings .....	6
Table 1.2	Operating Conditions.....	6
Table 1.3	Electrical Parameters .....	6
Table 4.1	Pin Description SOT89-5.....	17
Table 4.2	Package Dimensions SOT89-5 .....	17



## 1 IC Characteristics

### 1.1 Absolute Maximum Ratings

**Table 1.1** Absolute Maximum Ratings

No.	PARAMETER	SYMBOL	CONDITIONS	MIN	TYP	MAX	UNIT
1.1.1	Input voltage	$V_{IN}$		-0.3		50	V
1.1.2	I <sub>SENSE</sub> voltage	$V_{ISENSE}$	$V_{IN} > 5V$	$V_{IN} - 5$		$V_{IN} + 0.3$	V
			$V_{IN} < 5V$	0		$V_{IN} + 0.3$	V
1.1.3	LX output voltage	$V_{LX}$		-0.3		50	V
1.1.4	Adjust pin input voltage	$V_{ADJ}$		-0.3		6	V
1.1.5	Switch output current	$I_{LX}$	SOT89-5			900	mA
1.1.6	Power dissipation	$P_{tot}$	SOT89-5			1200	mW
1.1.7	Storage temperature	$T_{ST}$		-55		150	°C
1.1.8	Junction temperature	$T_{jMAX}$				150	°C

### 1.2 Operating Conditions

**Table 1.2** Operating Conditions

No.	PARAMETER	SYMBOL	CONDITIONS	MIN	TYP	MAX	UNIT
1.2.1	Operating temperature	$T_{OP}$		-40		+85	°C
1.2.2	Input voltage	$V_{IN}$		6		40	V

### 1.3 Electrical Parameters

Production testing is at 25°C. At other temperatures within the specified operating range, functional operation of the chip and specified parameters are guaranteed by characterization, design, and process control.

Test conditions are  $T_{amb} = 25^{\circ}C$ ;  $V_{IN} = 12V$  except as noted.

**Table 1.3** Electrical Parameters

No.	PARAMETER	SYMBOL	CONDITIONS	MIN	TYP	MAX	UNIT
1.3.1	Quiescent supply current with output off	$I_{INQoff}$	ADJ pin grounded	40	60	80	μA
1.3.2	Quiescent supply current with output switching	$I_{INQon}$	ADJ pin floating		450	600	μA
1.3.3	Mean current sense threshold voltage	$V_{SENSE}$		91	95	101	mV
1.3.4	Sense threshold hysteresis	$V_{SENSEHYS}$			±15		%
1.3.5	I <sub>SENSE</sub> pin input current	$I_{SENSE}$	$V_{SENSE} = 0.1V$		8	10	μA
1.3.6	Internal reference voltage	$V_{REF}$	Measured on ADJ pin with pin floating		1.2		V
1.3.7	External control voltage range on ADJ pin for DC brightness control	$V_{ADJ}$		0.3		1.2	V

# ZLED7000

40V LED Driver with Internal Switch



**ZMDI**<sup>®</sup>

The Analog Mixed Signal Company

No.	PARAMETER	SYMBOL	CONDITIONS	MIN	TYP	MAX	UNIT
1.3.8	DC voltage on ADJ pin to switch chip from active (ON) state to quiescent (OFF) state	$V_{ADJoff}$	$V_{ADJ}$ falling	0.15	0.2	0.25	V
1.3.9	DC voltage on ADJ pin to switch chip from quiescent (OFF) state to active (ON) state	$V_{ADJon}$	$V_{ADJ}$ rising	0.2	0.25	0.3	V
1.3.10	Resistance between ADJ pin and $V_{REF}$	$R_{ADJ}$			500		k $\Omega$
1.3.11	Continuous LX switch current	$I_{LXmean}$			0.65	0.75	A
1.3.12	LX switch leakage current	$I_{LX(leak)}$				1	$\mu$ A
1.3.13	LX Switch ON resistance	$R_{LX}$			0.9	1.5	$\Omega$
1.3.14	Brightness control range at low frequency PWM signal	$D_{PWM(LF)}$	PWM frequency =100Hz PWM amplitude=5V, $V_{IN}=15V$ , $L=27\mu H$ , driving 1 LED		1200:1		
1.3.15	Brightness control range at high frequency PWM signal	$D_{PWM(HF)}$	PWM frequency =10kHz PWM amplitude=5V, $V_{IN}=15V$ , $L=27\mu H$ , driving 1 LED		13:1		
1.3.16	Operating frequency	$f_{LX}$	ADJ pin floating $L=100\mu H$ (0.82 $\Omega$ ) $I_{OUT}=350mA$ @ $V_{LED}=3.4V$ , driving 1 LED		154		kHz
1.3.17	Minimum switch ON time	$T_{ONmin}$	LX switch ON		200		ns
1.3.18	Minimum switch OFF time	$T_{OFFmin}$	LX switch OFF		200		ns
1.3.19	Recommended maximum operating frequency	$f_{LXmax}$				1	MHz
1.3.20	Recommended duty cycle range of output switch at $f_{LXmax}$	$D_{LX}$		0.2		0.8	
1.3.21	Internal comparator propagation delay	$T_{PD}$			50		ns
1.3.22	Thermal shutdown temperature	$T_{SD}$			140		$^{\circ}C$
1.3.23	Thermal shutdown hysteresis	$T_{SD-HYS}$			20		$^{\circ}C$



# ZLED7000

40V LED Driver with Internal Switch



The Analog Mixed Signal Company



## 1.4 Characteristic Operating Curves

The curves are valid for the typical application circuit and  $T_{amb} = 25^{\circ}\text{C}$  unless otherwise noted.

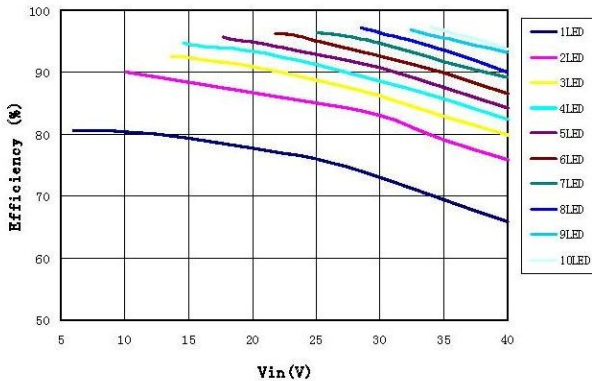

Efficiency vs. No. of LEDs  
 $L=100\mu\text{H}$ ,  $R_s=0.33\Omega$

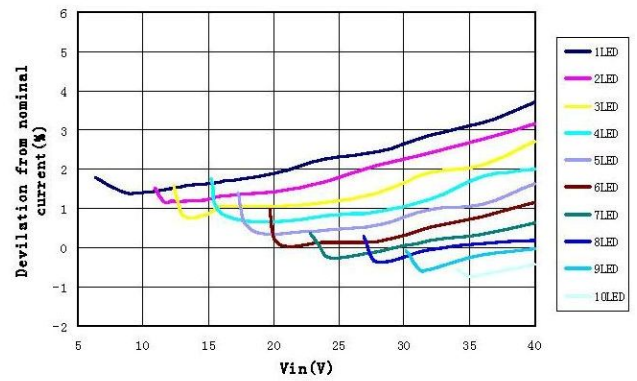

Output current variation with Supply Voltage  
 $L=100\mu\text{H}$ ,  $R_s=0.33\Omega$

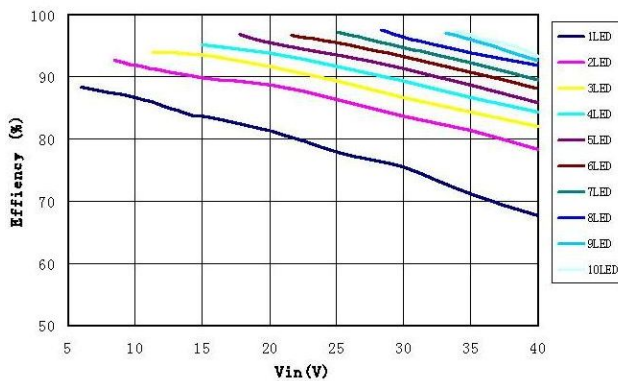

Efficiency vs. No. of LEDs  
 $L=47\mu\text{H}$ ,  $R_s=0.33\Omega$

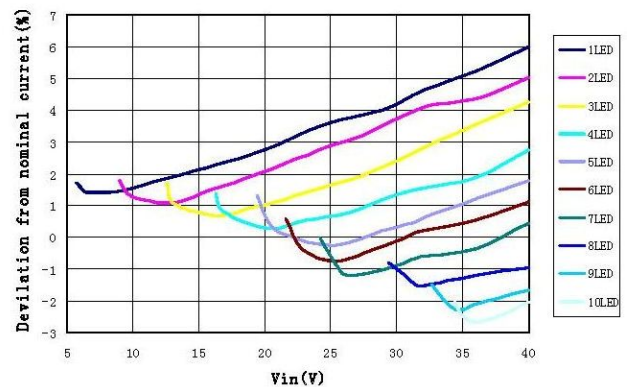

Output current variation with Supply Voltage  
 $L=47\mu\text{H}$ ,  $R_s=0.33\Omega$



# ZLED7000

40V LED Driver with Internal Switch



The Analog Mixed Signal Company

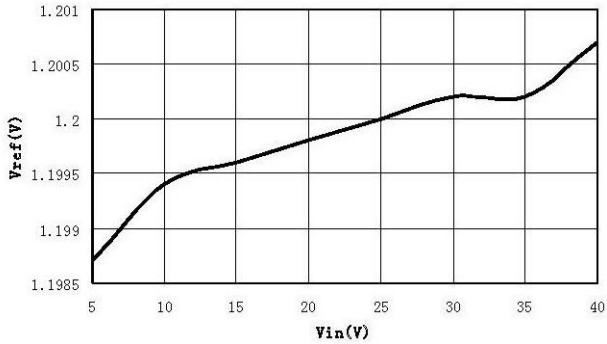

Vref vs. Vin over nominal supply voltage range

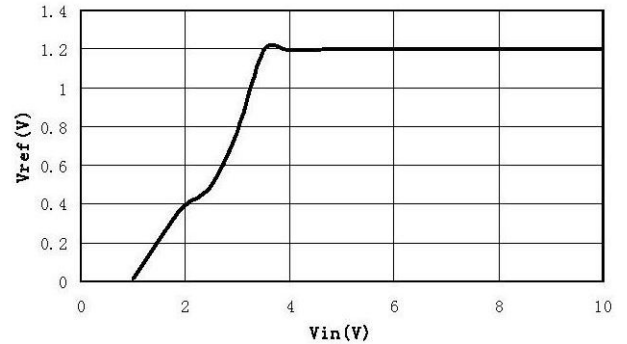

Vref vs. Vin at low supply voltage

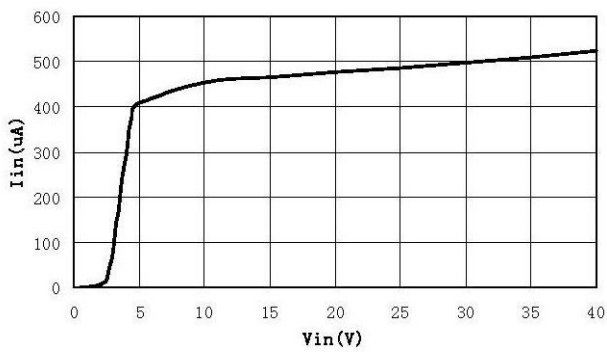

Supply Current vs. Vin (Operating)

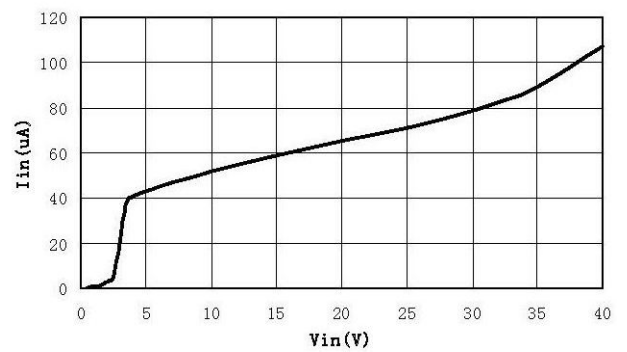

Shutdown Current vs. Vin (Quiescent)



## 2 Circuit Description

The ZLED7000 is an inductive step-down converter for driving LEDs. It operates in continuous mode, enabling proper LED current control. The ZLED7000 supports linear or PWM control of the LED current. Only a few external components are needed for typical applications.

### 2.1 Voltage Supply

The ZLED7000 has an internal regulator that disables the LX output until the voltage supply rises above a start-up threshold voltage set internally as needed to ensure that the power MOSFET on-resistance is low enough for proper operation. When the supply voltage exceeds the threshold, the ZLED7000 begins normal operation.

Important: The ZLED7000 must be operated within the operating voltage range specified in Table 1.2 to avoid conditions that could result in thermal damage to the ZLED7000. Operating with the supply voltage below the minimum can result in a high switch duty cycle and excessive ZLED7000 power dissipation, risking over-temperature conditions (also see section 4.1 regarding thermal restrictions) that could result in activation of the ZLED7000's thermal shut-down circuitry. With multiple LEDs, the forward drop is typically adequate to prevent the chip from switching below the minimum voltage supply specification (6V), so there is less risk of thermal shut-down.

### 2.2 ZLED7000 Standby Mode

Whenever the ADJ pin voltage falls below 0.2V, the ZLED7000 turns the output off and the supply current drops to approximately 60µA. This standby mode minimizes current consumption.

### 2.3 Output Current Control

The LED control current output on the LX pin is determined by the value of external components and the control voltage input at the ADJ pin. Selection of the external component  $R_S$  is discussed below, and other external components are discussed in section 2.3.4. The subsequent sections describe the two options for control voltage input at the ADJ pin: a pulse width modulation (PWM) control signal or a DC control voltage.

The ADJ pin has an input impedance<sup>†</sup> of 500kΩ ±25%.

#### 2.3.1 Output Current and $R_S$

The current sense threshold voltage and the value of the external current sense resistor ( $R_S$ ) between  $V_{IN}$  and  $I_{SENSE}$  set the output current through the LEDs ( $I_{OUT}$ ). Equation (1) below shows this basic relationship. Unless the ADJ pin is driven from an external voltage (see section 2.3.3), the minimum value for  $R_S$  is 0.13 Ω to prevent exceeding the maximum switch current (see Table 1.1).

$$I_{OUT} = \frac{95mV}{R_S} \quad (1)$$

Where

$I_{OUT}$  = Nominal average output current through the LED(s)

$R_S$  ≥ 0.13Ω

<sup>†</sup> At room temperature.



### 2.3.2 PWM Control

The output current on LX can be set to a value below the nominal average value determined by resistor  $R_S$  by using an external PWM signal as the control signal applied to the ADJ pin. This control signal must be capable of driving the ZLED7000's internal 500k $\Omega$  pull-up resistor. See Figure 2.1 for an illustration. The minimum signal voltage range is 0V to 1.8V; the maximum voltage range is 0V to 5V. See Table 1.3 for the specifications for the signal's duty cycle  $D_{PWM}$ . Any negative spikes on the control signal could interfere with current control or proper operation of the ZLED7000.

**Figure 2.1** Directly Driving ADJ Input with a PWM Control Signal

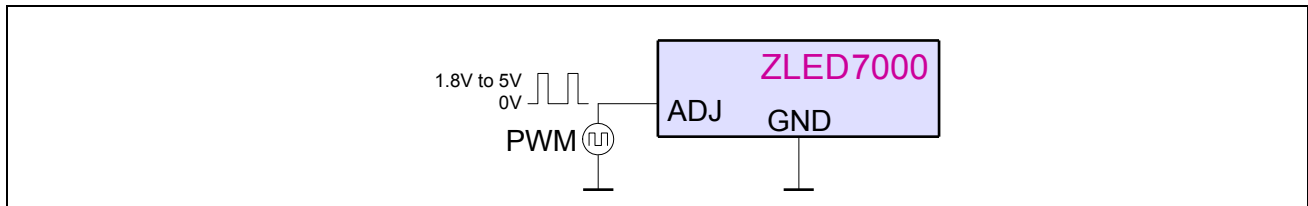

### 2.3.3 External DC Voltage Control of Output Current

The output current on LX can be set to a value below the nominal average value determined by resistor  $R_S$  by using an external DC voltage  $V_{ADJ}$  ( $0.3\text{ V} \leq V_{ADJ} \leq 1.2\text{ V}$ ) to drive the voltage at the ADJ pin. This allows adjusting the output current from 25% to 100% of  $I_{OUTnom}$ . See Figure 2.2 for an illustration. The output current can be calculated using equation (2). If  $V_{ADJ}$  matches or exceeds  $V_{REF}$  (1.2V), the brightness setting is clamped at its maximum (100%).

**Figure 2.2** External DC Control Voltage at ADJ Pin

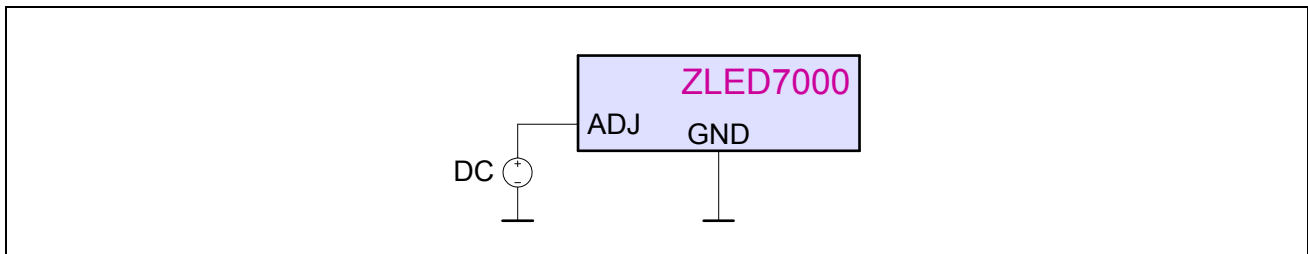

$$I_{OUT\_DC} = \frac{0.079 * V_{ADJ}}{R_S} \quad (2)$$

Where

$I_{OUT\_DC}$  = Nominal average output current through the LED(s) with a DC control voltage

$V_{ADJ}$  = External DC control voltage:  $0.3\text{ V} \leq V_{ADJ} \leq 1.2\text{ V}$

$R_S \geq 0.13\Omega$

# ZLED7000

40V LED Driver with Internal Switch



## 2.3.4 Microcontroller LED Control

A microcontroller's open-drain output can control current to the LED(s) by outputting a PWM control signal to the ADJ input of the ZLED7000. See Figure 2.1 for an example circuit.

**Figure 2.3** *Driving ADJ Input from a Microcontroller*

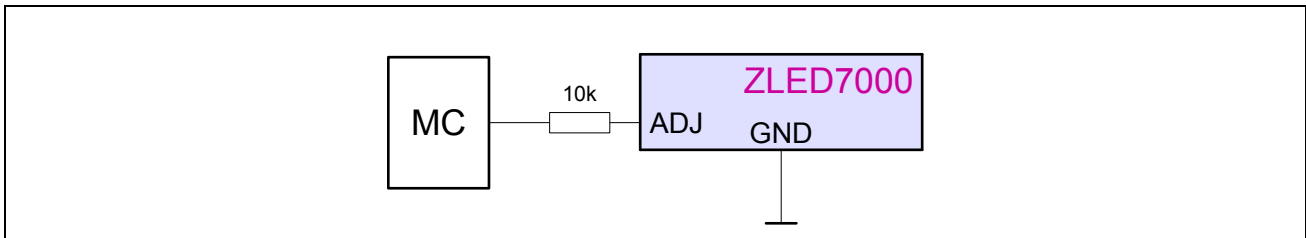



### 3 Application Circuit Design

The following sections cover selection of the external components shown in the typical application illustrated on page 2.

#### 3.1 External Component – Inductor L1

Select the inductor value for L1 as needed to ensure that switch on/off times are optimized across the load current and supply voltage ranges. Select a coil that has a continuous current rating above the required average output current to the LEDs and a saturation current exceeding the peak output current. Recommendation: Use inductors in the range of 15µH to 220µH with saturation current greater than 1A for 700mA output current or saturation current greater than 500mA for 350mA output current. For higher supply voltages with low output current, select higher values of inductance, which result in a smaller change in output current across the supply voltage range (refer to the graphs in section 1.4). See section 7.6 for layout restrictions.

Equations (3) and (4) illustrate calculating the timing for LX switching for the example application circuit shown on page 2. As given in Table 1.3, the minimum period for T<sub>ON</sub> is 200ns; the minimum period for T<sub>OFF</sub> is also 200ns.

#### LX Switch OFF Time $T_{OFF}$ in s

$$T_{OFF} = \frac{L * \Delta I}{V_{LED} + V_D + I_{AVG} * (R_S + r_L)} \quad (3)$$

#### LX Switch ON Time $T_{ON}$ in s

$$T_{ON} = \frac{L * \Delta I}{V_{IN} - V_{LED} - I_{AVG} * (R_S + r_L + R_{LX})} \quad (4)$$

#### Where

$L$	Coil inductance in H
$\Delta I$	Coil peak-peak ripple current in A *
$V_{LED}$	Total LED forward voltage in V
$V_D$	Diode forward voltage at the required load current in V
$I_{AVG}$	Required average LED current in A
$R_S$	External current sense resistance in $\Omega$
$r_L$	Coil resistance in $\Omega$
$V_{IN}$	Supply voltage in V
$R_{LX}$	Switch resistance in $\Omega$

\* With the ZLED7000, the current ripple  $\Delta I$  is internally set to an appropriate value of  $0.3 * I_{AVG}$ .

The inductance value has an equivalent effect on Ton and Toff and therefore affects the switching frequency. For the same reason, the inductance has no influence on the duty cycle for which the relation of the summed LED forward voltages  $n * V_F$  to the input voltage  $V_{IN}$  is a reasonable approximation. Because the input voltage is a factor in the ON time, variations in the input voltage affect the switching frequency and duty cycle.



The following calculation example yields an operating frequency of 122kHz and a duty cycle of 0.33:

Input data:  $V_{IN}=12V$ ,  $L=220\mu H$ ,  $r_L=0.48\Omega$ ,  $V_{LED}=3.4V$ ,  $I_{AVG}=333mA$  and  $V_D=0.36V$

$$T_{OFF} = \frac{220\mu H * 0.3 * 0.333 A}{3.4V + 0.36V + 0.333 A * (0.48\Omega + 0.3\Omega)} = 5.47\mu s \quad (5)$$

And

$$T_{ON} = \frac{220\mu H * 0.3 * 0.333 A}{12V - 3.4V - 0.333 A * (0.3\Omega + 0.48\Omega + 0.9\Omega)} = 2.73\mu s \quad (6)$$

### 3.2 External Component – Capacitor C1

To improve system efficiency, use a low-equivalent-series-resistance (ESR) capacitor for input decoupling because this capacitor must pass the input current AC component. The capacitor value is defined by the target maximum ripple of the supply voltage; the value is given by equation (7).

$$C_{MIN} = \frac{I_F * T_{ON}}{\Delta V_{MAX}} \quad (7)$$

#### Where

- $I_F$  Value of output current
- $\Delta V_{MAX}$  Maximum ripple of power supply
- $T_{ON}$  Maximum ON time of MOSFET

In the case of an AC supply with a rectifier, the capacitor value must be chosen high enough to make sure that the DC voltage does not drop below the maximum forward voltage of the LED string plus some margin for the voltage drops across the coil resistance, shunt resistor, and ON resistance of the switching transistor.

Recommendation: Use capacitors with X5R, X7R, or better dielectric for maximum stability over temperature and voltage. Do not use Y5V capacitors for decoupling in this application. For higher capacitance values, aluminum electrolytic caps with high switching capability should be used. In this case, improved performance can be reached by an additional X7R/X5R bypass capacitor of at least 100nF.

### 3.3 External Component – Diode D1

For the rectifier D1, select a high-speed, low-capacitance Schottky diode with low reverse leakage at the maximum operating voltage and temperature to ensure maximum efficiency and performance.

Important: Choose diodes with a continuous current rating higher than the maximum output load current and a peak current rating above the peak coil current. When operating above 85°C, the reverse leakage of the diode must be addressed because it can cause excessive power dissipation in the ZLED7000.

Note: Silicon diodes have a greater forward voltage and overshoot caused by reverse recovery time, which can increase the peak voltage on the LX output. Ensure that the total voltage appearing on the LX pin, including supply ripple, is within the specified range (see Table 1.1).

# ZLED7000

40V LED Driver with Internal Switch



## 3.4 Output Ripple

Shunt a capacitor  $C_{LED}$  across the LED(s) as shown in Figure 3.1 to minimize the peak-to-peak ripple current in the LED if necessary.

**Figure 3.1** Output Ripple Reduction

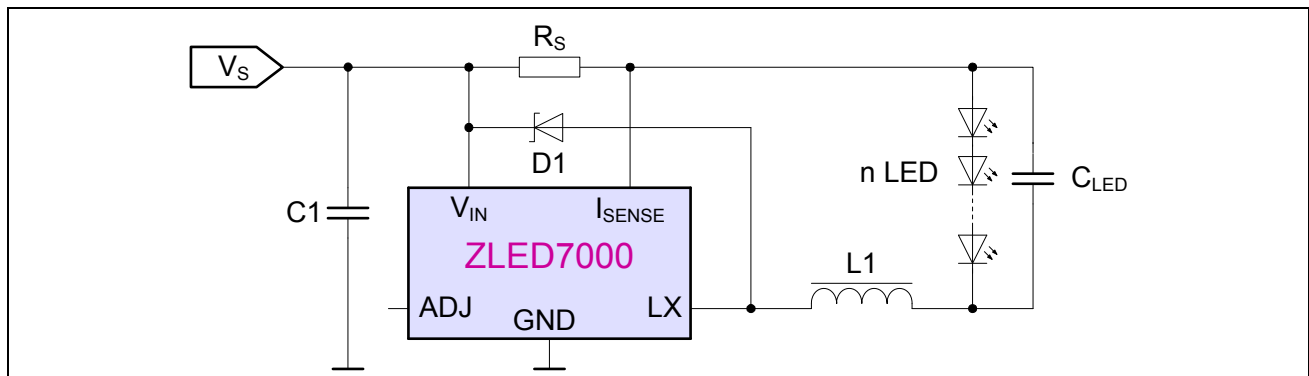

Low ESR capacitors should be used because the efficiency of  $C_{LED}$  largely depends on its ESR and the dynamic resistance of the LED(s). For an increased number of LEDs, using the same capacitor will be more effective. Lower ripple can be achieved with higher capacitor values, but this will increase start-up delay by reducing the slope of the LED voltage. The capacitor will not affect operating frequency or efficiency. For a simulation or bench optimization,  $C_{LED}$  values of a few  $\mu F$  are an applicable starting point for the given configuration.



# ZLED7000

40V LED Driver with Internal Switch



## 4 Operating Conditions

### 4.1 Thermal Conditions

Refer to Table 1.1 for maximum package power dissipation specifications for the ZLED7000's SOT89-5 package. Exceeding these specifications due to operating the chip at high ambient temperatures (see Table 1.2 for maximum operating temperature range) or driving over the maximum load current (see Table 1.1) can damage the ZLED7000. The ZLED7000 can be used for LED current applications up to 750mA when properly mounted to a high wattage land pattern. Conditions such as operating below the minimum supply voltage or inefficiency of the circuit due to improper coil selection or excessive parasitic capacitance on the output can cause excessive chip power dissipation.

### 4.2 Thermal Shut-Down Protection

The ZLED7000 includes an on-board temperature sensing circuit which stops the output if the junction exceeds approximately 160°C.

### 4.3 Open-Circuit Protection

The ZLED7000 is inherently protected if there is an open-circuit in the connection to the LEDs because in this case, the coil is isolated from the LX pin. This prevents any back EMF from damaging the internal switch due to forcing the drain above its breakdown voltage.

## 5 ESD/Latch-Up-Protection

All pins have an ESD protection of  $>\pm 2000V$  according to the Human Body Model (HBM) except for pin 1, which has a protection level of  $>\pm 1000V$ . The ESD test follows the Human Body Model with 1.5 k $\Omega$ /100 pF based on MIL 883-G, Method 3015.7

Latch-up protection of  $>\pm 100mA$  has been proven based on JEDEC No. 78A Feb. 2006, temperature class 1.



## 6 Pin Configuration and Package

Figure 6.1 Pin Configuration and Package Drawing SOT89-5

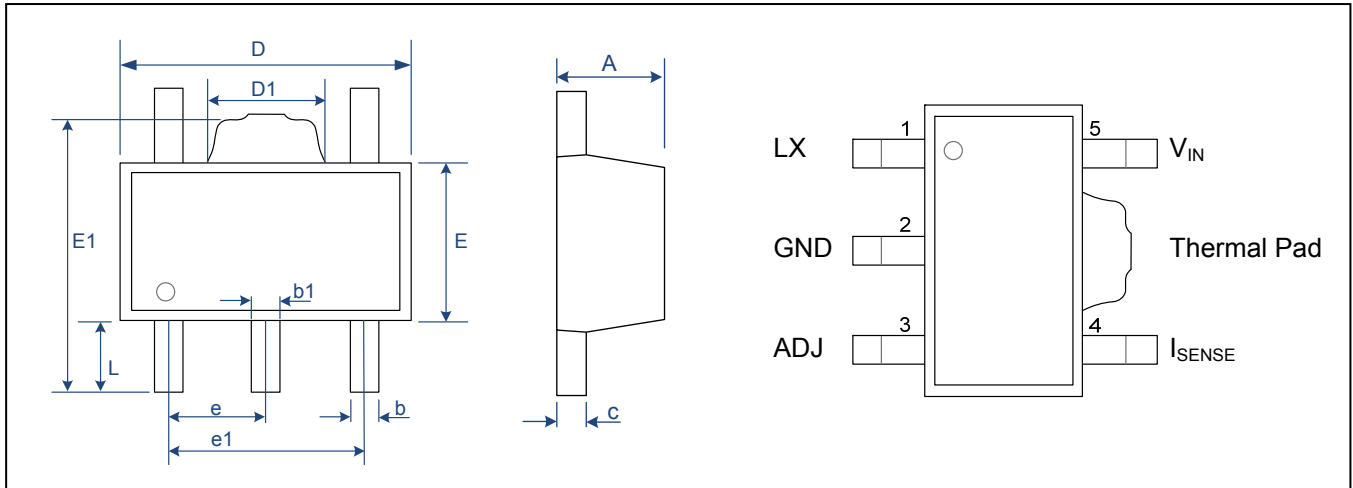

Table 4.1 Pin Description SOT89-5

Pin Name	No.	Description
LX	1	Power switch drain
GND	2	Ground (0V)—see section 7.4 for layout considerations
ADJ	3	Output current control pin—see section 2.3 for details
ISENSE	4	Nominal average output current is set by the value of a resistor $R_S$ connected from ISENSE to $V_{IN}$ – see section 2.3.1 for details
VIN	5	Supply voltage (6V to 40V)—see section 7.3 for layout considerations

Table 4.2 Package Dimensions SOT89-5

Symbol	Dimension (mm)		Symbol	Dimension (mm)	
	Min	Max		Min	Max
A	1.400	1.600	E	2.300	2.600
b	0.320	0.520	E1	3.940	4.250
b1	0.360	0.560	e	1.500 Typ	
c	0.350	0.440	e1	2.900	3.100
D	4.400	4.600	L	0.900	1.100
D1	1.400	1.800			

The SOT89-5 package has a thermal resistance (junction to ambient) of  $R_{\theta JA} = 45 \text{ K/W}$ .

# ZLED7000

40V LED Driver with Internal Switch



## 7 Layout Requirements

### 7.1 Layout Considerations for ADJ (Pin 3)

For applications in which the ADJ pin is unconnected, minimize the length of circuit board traces connected to ADJ to reduce noise coupling through this high impedance input.

### 7.2 Layout Considerations for LX (Pin 1)

Minimize the length of circuit board traces connected to the LX pin because it is a fast switching output.

### 7.3 Layout Considerations for $V_{IN}$ (Pin 5) and the External Decoupling Capacitor (C1)

The C1 input decoupling capacitor must be placed as close as possible to the VIN pin to minimize power supply noise, which can reduce efficiency. See section 3.2 regarding capacitor selection.

### 7.4 Layout Considerations for GND (Pin 2)

The ZLED7000 GND (ground) pin must be soldered directly to the circuit board's ground plane to minimize ground bounce due to fast switching of the LX pin.

### 7.5 Layout Considerations for High Voltage Traces

Avoid laying out any high voltage traces near the ADJ pin to minimize the risk of leakage in cases of board contamination, which could raise the ADJ pin voltage resulting in unintentional output current. Leakage current can be minimized by laying out a ground ring around the ADJ pin.

### 7.6 Layout Considerations for the External Coil (L1)

The L1 coil must be placed as close as possible to the chip to minimize parasitic resistance and inductance, which can reduce efficiency. The connection between the coil and the LX pin must be low resistance.

### 7.7 Layout Considerations for the External Current Sense Resistor ( $R_S$ )

Any trace resistance in series with  $R_S$  must be taken into consideration when selecting the value for  $R_S$ .

## 8 Ordering Information

Product Sales Code	Description	Package
ZLED7000-Z11R	ZLED7000 – 40V LED Driver	SOT89-5 (Tape & Reel)
ZLED7000KIT-D1	ZLED7000 used in a MR16 Halogen replacement Demo Kit 12VAC/VDC, including 1 ZLED-PCB1	Kit
ZLED-PCB1	Test PCB with one 3W white High Brightness (HB) LED, cascable to one multiple LED string	Printed Circuit Board (PCB)
ZLED-PCB2	10 unpopulated test PCBs for modular LED string with footprints of 9 common HB LED types	Printed Circuit Board (PCB)

# ZLED7000

40V LED Driver with Internal Switch



**ZMDI**<sup>®</sup>

The Analog Mixed Signal Company

## 9 Document Revision History

Revision	Date	Description
1.0	June 10, 2010	Production release version
1.1	August 12, 2010	Revision to equation (5) for Toff. Update for contact information.

### Sales and Further Information

[www.zmdi.com](http://www.zmdi.com)

[LED\\_Drivers@zmdi.com](mailto:LED_Drivers@zmdi.com)

#### Zentrum Mikroelektronik Dresden AG (ZMD AG)

Grenzstrasse 28  
01109 Dresden  
Germany

Phone +49 (0)351.8822.7.533  
Fax +49(0)351.8822.8.7533

#### ZMD America, Inc.

8413 Excelsior Drive  
Suite 200  
Madison, WI 53717  
USA

Phone +1 (608) 829-1987  
Fax +1 (631) 549-2882

#### Zentrum Mikroelektronik Dresden AG, Japan Office

2nd Floor, Shinbashi Tokyu Bldg.  
4-21-3, Shinbashi, Minato-ku  
Tokyo, 105-0004  
Japan

Phone +81.3.6895.7410  
Fax +81.3.6895.7301

#### ZMD Far East, Ltd.

3F, No. 51, Sec. 2,  
Keelung Road  
11052 Taipei  
Taiwan

Phone +886.2.2377.8189  
Fax +886.2.2377.8199

**DISCLAIMER:** This information applies to a product under development. Its characteristics and specifications are subject to change without notice. Zentrum Mikroelektronik Dresden AG (ZMD AG) assumes no obligation regarding future manufacture unless otherwise agreed to in writing. The information furnished hereby is believed to be true and accurate. However, under no circumstances shall ZMD AG be liable to any customer, licensee, or any other third party for any special, indirect, incidental, or consequential damages of any kind or nature whatsoever arising out of or in any way related to the furnishing, performance, or use of this technical data. ZMD AG hereby expressly disclaims any liability of ZMD AG to any customer, licensee or any other third party, and any such customer, licensee and any other third party hereby waives any liability of ZMD AG for any damages in connection with or arising out of the furnishing, performance or use of this technical data, whether based on contract, warranty, tort (including negligence), strict liability, or otherwise.

**Data Sheet**  
August 12, 2010

© 2010 Zentrum Mikroelektronik Dresden AG — Rev. 1.1

All rights reserved. The material contained herein may not be reproduced, adapted, merged, translated, stored, or used without the prior written consent of the copyright owner. The information furnished in this publication is subject to changes without notice.

19 of 19